

Table of Contents

Foreword	3
Precautions	5
1. Introduction	7
1.1. What Your LaCie Two Big Can Do	7
2. Your LaCie Two Big	8
2.1. Minimum System Requirements	8
2.2. Package Contents	9
2.3. Views Of The Drive	10
2.3.1. Front View	10
2.3.2. Front View without Front Panel	10
2.3.3. Rear View	11
2.4. Cables & Connectors	12
2.4.1. Serial ATA II and eSATA	12
3. Setting Up Your LaCie Two Big	13
3.1. Set up the Two Big	14
3.2. Storage Policies	15
3.3. Changing the Storage Policy Configuration	16
3.4. Partitioning the LaCie Two Big Disk Drives	18
3.4.1. Partitioning the LaCie Two Big Disk Drives — Windows	18
3.4.2. Partitioning the LaCie Two Big Disk Drives — Mac	23
4. Maintaining Your LaCie Two Big	25
4.1. Removing/replacing a drive	25
4.2. Firmware updates	26
5. LaCie Two Big Front Panel LED Indicators	27
6. Tech Tips	28
6.1. Available Storage Capacity	28
6.2. File System Formats	29
6.2.1. File System Formats — Mac Users	29
6.2.2. File System Formats — Windows Users	30
6.3. Serial ATA II Questions and Answers	31
7. Understanding RAID and Two Big Storage Policies	33
7.1. RAID 0 (Fast)	33
7.2. RAID 1 (Safe)	35

7.3. Concatenation (Big)	36
7.4. JBOD	37
8. Troubleshooting	38
8.1. LEDs and Fan	39
8.2. LaCie Two Big connection to LaCie SATA II 3Gb/s PCI-X Card 4E	40
9. Contacting Customer Support	41
10. Warranty	43

Copyrights

Copyright © 2005 LaCie. All rights reserved. No part of this publication may be reproduced, stored in a retrieval system, or transmitted in any form or by any means, electronic, mechanical, photocopying, recording or otherwise, without the prior written consent of LaCie.

Trademarks

Apple, Mac, Macintosh and FireWire are registered trademarks of Apple Computer, Inc. Microsoft, Windows NT, Windows 98, Windows 98 SE, Windows 2000, Windows Millennium Edition and Windows XP are registered trademarks of Microsoft Corporation. Sony and iLink are registered trademarks of Sony Electronics. Other trademarks mentioned in this manual are the property of their respective owners.

Changes

The material in this document is for information only and subject to change without notice. While reasonable efforts have been made in the preparation of this document to assure its accuracy, LaCie assumes no liability resulting from errors or omissions in this document, or from the use of the information contained herein. LaCie reserves the right to make changes or revisions in the product design or the product manual without reservation and without obligation to notify any person of such revisions and changes.

FCC Statement

This device complies with Part 15 of the FCC Rules. Operation is subject to the following conditions:

1. The devices may not cause harmful interference
2. The devices must accept any interference received, including interference that may cause undesired operation.



CAUTION: Modifications not authorized by the manufacturer may void the user's authority to operate this device.

NOTE: This equipment has been tested and found to comply with the limits for a Class B digital device, pursuant to Part 15 of the FCC Rules. These limits are designed to provide reasonable protection against harmful interference in a residential installation. This equipment generates, uses and can radiate radio frequency energy and, if not installed and used in accordance with the instructions, may cause harmful interference to radio communications. However, there is no guarantee that interference will not occur in a particular installation. If this equipment does cause harmful interference to radio or television reception, which can be determined by turning the equipment off and on, the user is encouraged to try and correct the

interference by one or more of the following measures:

- Reorient or relocate the receiving antenna.
- Increase the separation between the equipment and receiver.
- Connect the equipment into an outlet on a circuit different from that to which the receiver is connected.
- Consult the dealer or an experienced radio/TV technician for help.



CAUTION: A shielded-type power cord is required in order to meet FCC emission limits and also to prevent interference to the nearby radio and television reception. It is essential that only the supplied power cord be used.

Modifications to this product not authorized by LaCie could void the FCC & Industry Canada regulations and negate your authority to operate the product.

Canada Compliance Statement

This Class B digital apparatus complies with Canadian ICES-003.



Manufacturer's Declaration for CE Certification

We, LaCie, solemnly declare that this product conforms to the following European standards:

Class B EN60950-1:2003, EN55022: 1998, EN55024:1998 +A1, EN61000-3-2: 2000, EN61000-3-3:2001

With reference to the following conditions:

73/23/EEC Low Voltage Directive

89/336/EEC EMC Directive



This symbol on the product or on its packaging indicates that this product must not be disposed of with your other household waste. Instead, it is your responsibility to dispose of your waste equipment by handing it over to a designed collection point for the recycling of waste electrical and electronic equipment. The separate collection and recycling of your waste equipment at the time of disposal will help to conserve natural resources and ensure that it is recycled in a manner that protects human health and the environment. For more information about where you can drop off your waste equipment for recycling, please contact your local city office, your household waste disposal service, or the shop where you purchased the product.

Health and Safety Precautions

Only qualified persons are authorized to carry out maintenance on this device.

- Read this User Manual carefully and follow the correct procedure when setting up the device.
- Do not open a disk drive or attempt to disassemble or modify it. Never insert any metallic object into the drive to avoid any risk of electrical shock, fire, short-circuiting or dangerous emissions. The disk drives shipped with your LaCie Two Big contain no user-serviceable parts. If it appears to be malfunctioning, have it inspected by a qualified LaCie Technical Support representative.
- Never expose your device to rain, or use it near water, or in damp or wet conditions. Never place objects containing liquids on the LaCie Two Big, as they may spill into its openings. Doing so increases the risk of electrical shock, short-circuiting, fire or personal injury.
- Make sure that the computer and LaCie Two Big are electrically grounded. If the devices are not grounded, there is an increased risk of electrical shock. Power requirements 100-240 V~, 1.5 A, 60-50 Hz, (Supply voltage fluctuations not exceeding $\pm 10\%$ of the nominal, transient over-voltages according to over-voltage category II).

General Use Precautions

- Do not expose the LaCie Two Big to temperatures outside the range of 5° C to 35° C (41° F to 95° F); or to operational humidity beyond 5-80%, non-condensing, or non-operating humidity beyond 10-90%, non-condensing. Doing so may damage the LaCie Two Big or disfigure its casing. Avoid placing your LaCie Two Big near a source of heat or exposing it to sunlight (even through a window). Inversely, placing your LaCie Two Big in an environment that is too cold may damage the unit.
- Rated cooling for altitudes up to 2000 meters.
- Always unplug the LaCie Two Big from the electrical outlet if there is a risk of lightning or if it will be unused for an extended period of time. Otherwise, there is an increased risk of electrical shock, short-circuiting or fire.
- Use only the power supply shipped with the device.
- Do not use the LaCie Two Big near other electrical appliances such as televisions, radios or speakers. Doing so may cause interference which will adversely affect the operation of the other products.
- Do not place the LaCie Two Big near sources of magnetic interference, such as computer displays, televisions or speakers. Magnetic interference can affect the operation and stability of your LaCie Two Big.
- Do not place heavy objects on top of the LaCie Two Big or use excessive force on it.
- Never use excessive force on your LaCie Two Big. If you detect a problem, consult the Troubleshooting section in this manual.
- Protect your LaCie Two Big from excessive exposure to dust during use or storage. Dust can build up inside the device, increasing the risk of damage or malfunction.
- Never use benzene, paint thinners, detergent or other chemical products to clean the outside of the LaCie Two Big. Such

products will disfigure and discolor the casing. Instead, use a soft, dry cloth to wipe the device.

- Please replace defective hard drives only with a new drive provided by LaCie. For drive removal process, see section 4.1. [Removing/Replacing a Drive](#).



CAUTION: Drive warranty will be void if you replace the defective drive by a drive not purchased from LaCie.



CAUTION: The LaCie Two Big's warranty may be void as a result of the failure to respect the precautions listed above.

1. Introduction

Congratulations on the purchase of your new LaCie Two Big. This high-performance, extremely flexible RAID (Redundant Array of Independent/Inexpensive Disks) subsystem is ideally suited for integration with databases, imaging systems and e-mail and Web servers.

RAID technology is one of the best means to protect your data, while providing greater data integrity and availability than standard hard disk storage. With the ability to provide single error detection and redundant information to recover the original if a disk fails, a RAID system is an ideal means to safe-guard valuable data while also stream-lining performance.

The LaCie Two Big is the ultimate approach to a flexible RAID solution, with its ability to manage various RAID levels (0, 1, Concatenation, and JBOD).



1.1. What Your LaCie Two Big Can Do

- Supports powerful RAID 0, 1, Concatenation, and JBOD
- High-performance storage
- The newest in Serial ATA (SATA) technology
- Easy plug-and-play installation on PC or Mac

IMPORTANT INFO: Any loss, corruption or destruction of data while using a LaCie drive is the sole responsibility of the user, and under no circumstances will LaCie be held liable for the recovery or restoration of this data. To help prevent the loss of your data, LaCie highly recommends that you keep TWO copies of your data; one copy on your external hard drive, for instance, and a second copy either on your internal hard drive, another external hard drive or some other form of removable storage media, such as CD, DVD or Tape. LaCie offers a complete line of CD, DVD and Tape drives, and if you would like more information on backup, please refer to the LaCie white paper on backup methods and technology.

2. Your LaCie Two Big

2.1. Minimum System Requirements

Hardware

- For x86 platforms: Intel PIII 500MHz equivalent or faster
- For Mac platforms: Mac G4 500MHz or faster
- CD-ROM drive
- 64 MB of RAM minimum
- Mouse or compatible pointing device
- External SATA cable connection between the Two Big and the host computer

Software

- For x86 platforms: Microsoft Windows 2000, Windows XP, or Windows Server 2003 with the latest Service Pack installed.
- For Mac platforms: Mac OS 10.3.9 or later.
- LaCie SATA II PCI-X card CD

2.2. Package Contents

Your LaCie Two Big should ship with the system tower, an accessories box and the LaCie SATA II 3Gb/s PCI-X Card 4E. For information about the PCI-X Card, please consult the User Manual and Quick Install Guide packaged with it.

- 1 LaCie Two Big RAID system tower with two trayless, hot-swappable hard drives

Accessories box contents

- 2 SATA 3Gb/s external cable (2 meters)
- 3 LaCie Two Big Utilities CD-ROM (includes User Manual and Quick Install Guide)
- 4 LaCie Two Big Quick Install Guide (printed version)
- 5 External power supply
- 6 LaCie SATA II 3Gb/s PCI-X Card 4E
- 7 PCI-X Card CD-ROM (includes User Manual, Quick Install Guide and Drivers)
- 8 PCI-X Card Quick Install Guide (printed version)
- 9 Two plastic drive stands with rubber feet for drive stands

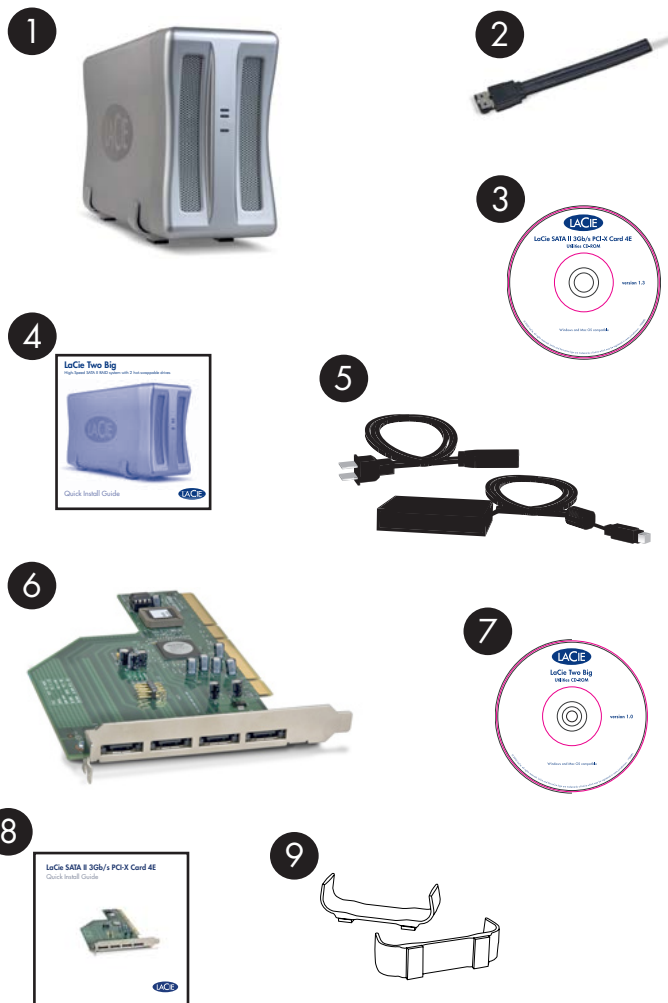

IMPORTANT INFO: Please keep your box. In the event that the LaCie Two Big RAID subsystem tower should need to be repaired or serviced, it must be returned in its original packaging. In the event that an individual disk should need to be repaired or serviced, please refer to section 4.1. [Removing/Replacing A Disk.](#)

2.3. Views Of The Drive

2.3.1. Front View

- 1 Drive LEDs – Indicate drive status
- 2 System LED – Indicates system on/off status
- 3 Panel removal tab
- 4 Two Plastic stands with rubber feet
- 5 Removable front panel

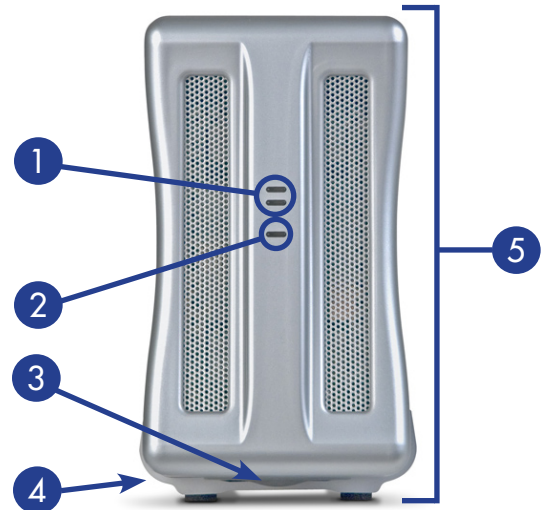

2.3.2. Front View without Front Panel

- 1 Handles to remove the drives
- 2 Drive slot 1
- 3 Drive slot 2



TECHNICAL NOTE: For more information about these LEDs, see Chapter 5. [LaCie Two Big Front Panel LED indicators.](#)

2.3.3. Rear View

- 1 Casing Fan
- 2 Mode change rotary switch
- 3 Power Switch
- 4 Mode change confirmation button
- 5 External SATA II 3Gb/s Port
- 6 Power Supply Connector
- 7 Plastic stands with rubber feet
- 8 Lock hole



CAUTION: To avoid overheating, the LaCie Two Big should be installed in a well-ventilated area and in such a way as to maintain sufficient airflow across the controller chips. Also ensure that the Ventilation Fan is not obstructed. Please use the included plastic stands and rubber feet which elevate the Two Big and allow for better heat dissipation.

Environmental Requirements:

Temperature: 0 – 35° C (32 – 95° F)

Operation Humidity: 20 – 80%, non-condensing

Storage Humidity: 10 – 90%, non-condensing

2.4. Cables And Connectors

2.4.1. Serial ATA II and eSATA

Your LaCie Two Big uses the latest in SATA technology, featuring transfer rates of up to 3Gb/s. Both the Two Big and the LaCie SATA II 3Gb/s PCI-X Card 4E come equipped with eSATA ports and require the use of an external SATA cable, (included). SATA technology was originally developed to serve as an internal interface, delivering improved performance to internal connections. Soon after, eSATA, or external SATA was developed, allowing for the use of shielded cables outside the PC.

eSATA technology was developed to be rugged and durable. eSATA connectors do not have the “L” shaped design of other SATA connectors. In addition, the guide features are vertically offset and reduced in size to prevent the use of unshielded internal cables in external applications.

eSATA Cables And Connectors

The cables and connectors used to attach Serial ATA drives to your computer are as follows:



Serial ATA Port



Serial ATA Cable

3. Setting Up Your LaCie Two Big

This chapter covers the installation and configuration of your LaCie Two Big. A relatively easy process, you will be guided through the five following steps:

[3.1. Set up the LaCie Two Big](#) – This process helps you to get your LaCie Two Big plugged in and ready to use.

[3.2. Storage Policies](#) – Terms to know before you configure the Storage Appliance. The terms represent LaCie Two Big configuration options.

[3.3. Changing the Storage Policy Configuration](#) – Your LaCie Two Big comes preconfigured in the FAST storage policy configuration. This process will modify the policy configuration.

[3.4. Partitioning the LaCie Two Big disk drives](#) – During this process, you will format the drives. For more information about file system formats, see chapter 6.2. [File System Formats](#).

3.1. Set up the LaCie Two Big

1. Make sure that the PCI-X card delivered with your LaCie Two Big has already been installed. Please refer to the card's Quick Install Guide for setup instructions.
2. Plug in the AC power adapter into the proper AC outlet (*fig. A-1*), and then turn on the Two Big using the switch on the back (*fig. A-2*).
3. Plug one end of the external SATA cable to the external SATA connector on your host computer. Connect the other end of the cable to the Two Big (*fig. B*).

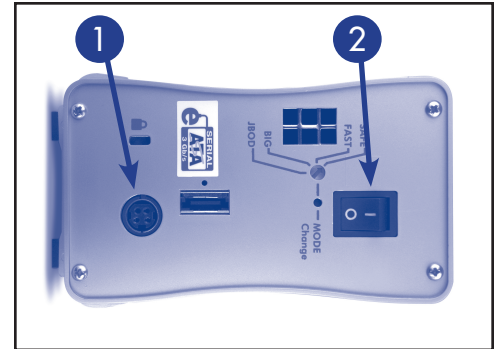

Fig. A

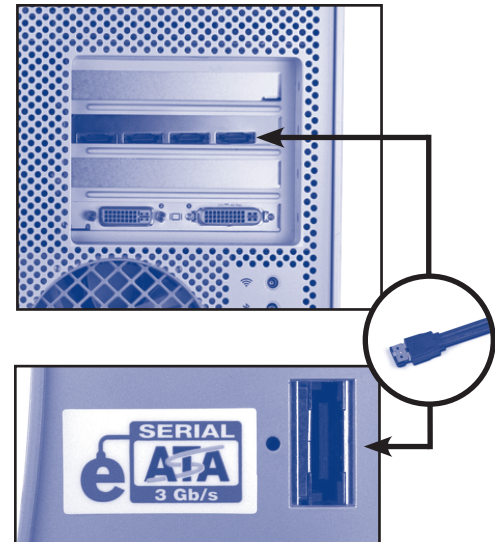



Fig. B

TECHNICAL NOTE: The LaCie Two Big default configuration is in **FAST (RAID 0)** mode. To change the storage policy configuration mode, see sections 3.3. [Storage Policies](#), 3.4. [Changing the Storage Policy Configuration](#), and 7. [Understanding RAID and Two Big Storage Policies](#).

TECHNICAL NOTE: The disks shipped with the unit are formatted **HFS+**.

3.2. Storage Policies

Before you use the LaCie Two Big Manager to configure the Storage Appliance, take a minute to study the following terms. The terms represent The LaCie Two Big configuration options or storage policies for mapping the physical to the virtual drives. You'll choose from these policies during the configuration process. Your choice is important and impacts how best you can use the Storage Appliance.

 **IMPORTANT INFO:** Your LaCie Two Big comes preconfigured in **FAST (RAID 0)** mode. For more information about RAID levels, see chapter 7. [Understanding RAID and Two Big Storage Policies.](#)

- FAST** A storage policy configuration in which I/O processing is balanced evenly to all disks in a method known as striping, equivalent to RAID 0. Fast offers the best performance in terms of speed but no redundancy of data. Striping increases storage operation speed by using several disk drives in parallel. Each portion of data is divided into segments which are written to different disks simultaneously. Striping provides improved performance but does not enhance reliability because there is no way to retrieve or reconstruct data stored on a failed drive. Please check the LaCie Web site, www.lacie.com, for updates of the User's Manual reflecting product updates.
- SAFE** A storage policy configuration in which all data is stored in duplicate on separate disks to protect against data loss due to disk failure. At least two drives mirror each other at all times, equivalent to RAID 1. Each write goes to both disks. Safe provides the highest level of data protection but halves the amount of storage space since all data must be stored twice. To implement the Safe storage policy, the Basic Configuration Wizard creates two volumes. Each volume consists of two hard disk drives that mirror each other.
- BIG** A storage policy configuration in which multiple physical drives are strung together (concatenated) and treated as one large volume. Big provides the maximum amount of storage space but no additional performance or data redundancy. This configuration allows you to increase logical volume size beyond the capacity of individual drives. The Basic Configuration Wizard implements the Big storage policy by concatenating all the hard disk drives into a single volume.
- JBOD** A storage policy that grants the host PC direct access to a physical disk drive. With JBOD (just a bunch of disks), the number of available drives is equal to the number of physical drives. JBOD is also called the bypass mode as the host bypasses the LaCie virtualization engine to directly access the disk.

 **TECHNICAL NOTE:** Total disk capacity can vary depending on the storage policy or RAID level.

3.3. Changing the Storage Policy Configuration

IMPORTANT INFO: Changing the Storage Policy destroys data stored on the LaCie storage device. If you have saved data on the drives, back up data before following these steps.

1. Turn off the LaCie Two Big.
2. Insert a small, flat-blade screwdriver into the groove on the rotary switch and turn the screwdriver handle to the left or right to select a different mode (*fig. A*).

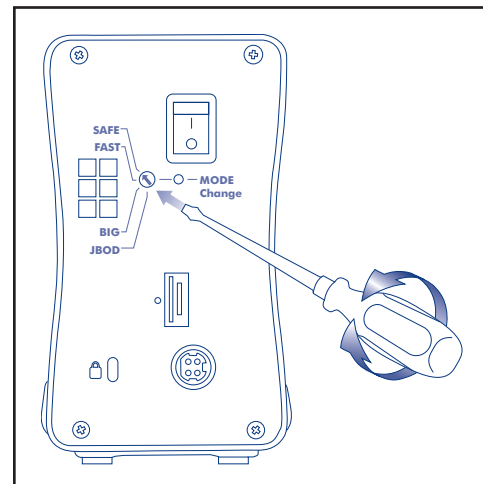

Fig. A

3. Remove the screwdriver from the rotary switch and use it to depress the MODE Change button (*fig. B*)

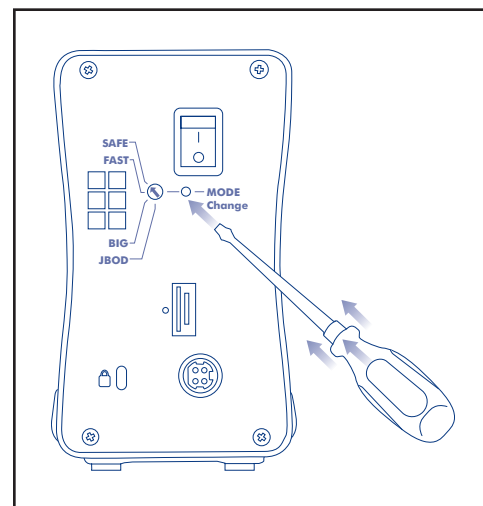

Fig. B

CAUTION: Disk Drives must be inserted correctly in the Two Big before configuration can be changed.

4. Turn on the LaCie Two Big while continuing to hold the MODE change button for 10 seconds before releasing it (*fig. C*)
5. If applicable, restore previously backed up data onto the appliance.

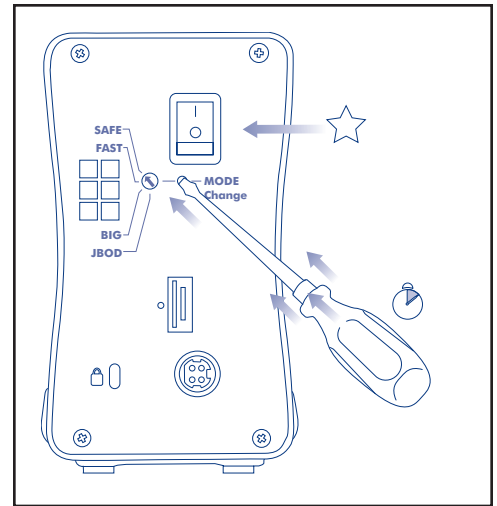

Fig. C



IMPORTANT INFO: You must partition the disk drives after changing the storage policy configuration.

3.4. Partitioning the LaCie Two Big Disk Drives

You must partition the drives after changing the Two Big configuration mode (SAFE, FAST, etc). During this process, you will format the drives. For more information about file system formats, see chapter 7.2 [File System Formats](#).

IMPORTANT INFO: Before reconfiguring a virtual drive, back up your data and delete previously defined volume partitions. Do not, however, delete the partition that represents the LaCie processor (the “Not Initialized” disk with no capacity allocated to it). After you configure and partition the new virtual drives, restore the backed-up data to the new configuration.

IMPORTANT INFO: The disks shipped with the LaCie Two Big are formatted HFS+. To use the drives with Windows operating systems or for cross-platform use between Mac and PC, the drives must be reformatted. For more information, see section 7.2 [File System Formats](#).

3.4.1. Partitioning the LaCie Two Big Disk Drives – Windows Users

IMPORTANT INFO: Remember, do not partition the disk that represents the LaCie Two Big processor (the “Not Initialized” disk with no capacity allocated to it).

This example illustrates the **FAST** storage policy, which optimizes the LaCie Two Big for performance.

1. Right-click the **My Computer** icon on your desktop and select **Manage** from the pop-up window (*fig. A*).

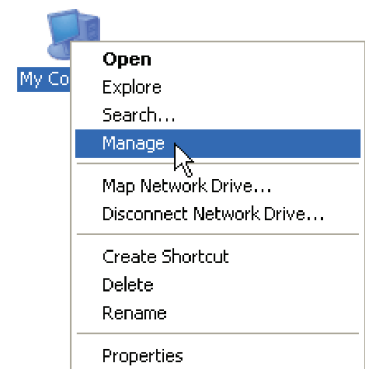

Fig. A

2. Select **Disk Management** under **Storage** to open the **Windows Disk Manager** (*fig. B*).

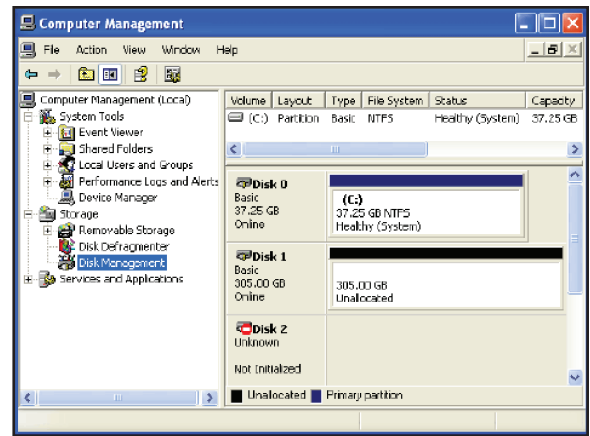

Fig. B

3. Right-click the configured disk's unallocated space and select **New Partition**. If the New Partition option is not available, select the disk and initialize it first (*fig. C*).

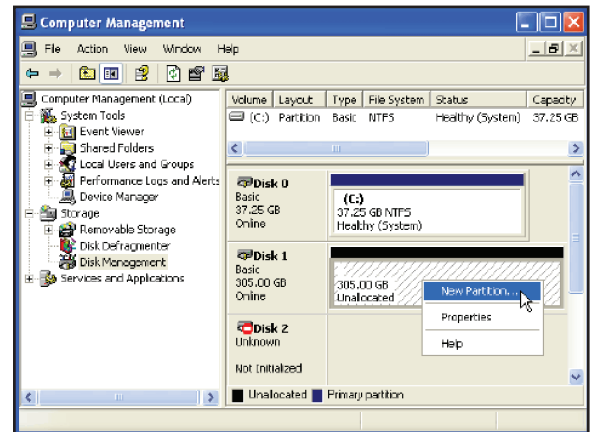

Fig. C

4. Click **Next** to start the Partition Wizard (*fig. D*).

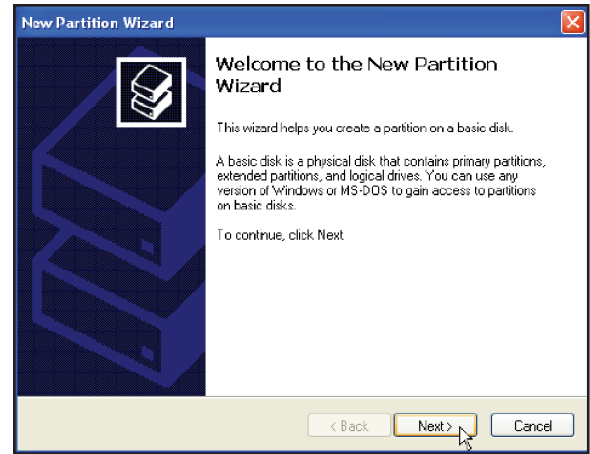

Fig. D

5. Select the **Primary** or **Extended** option and click **Next** (*fig. E*).

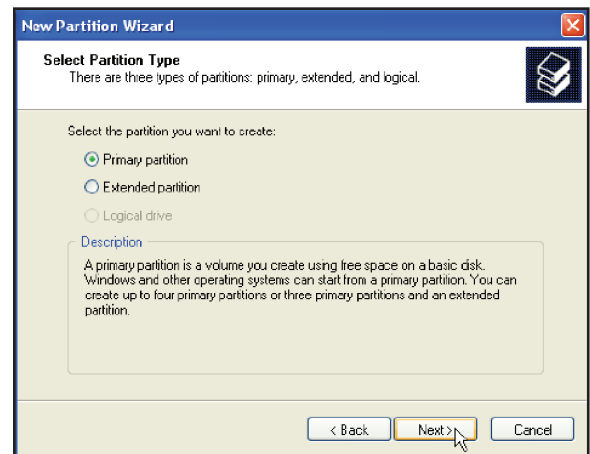

Fig. E

6. Specify the partition size. By default, the partition occupies the entire volume. Click **Next** (fig. F).

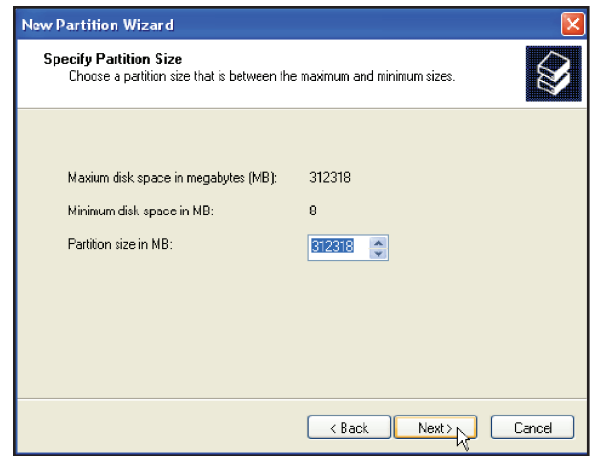

Fig. F

7. Assign a drive letter or mount path and click **Next** (fig. G).

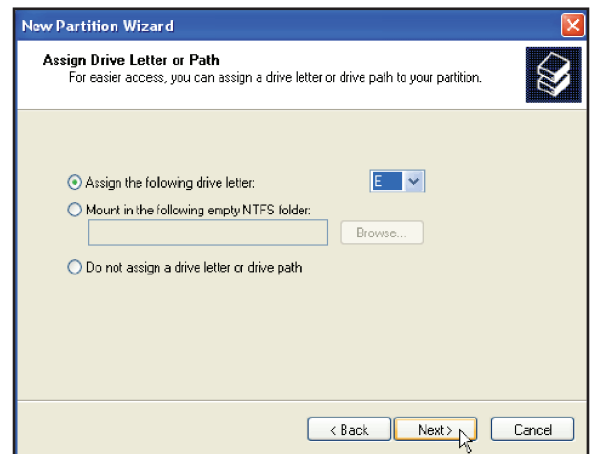

Fig. G

8. Name and format the partition and click **Next** (fig. H).

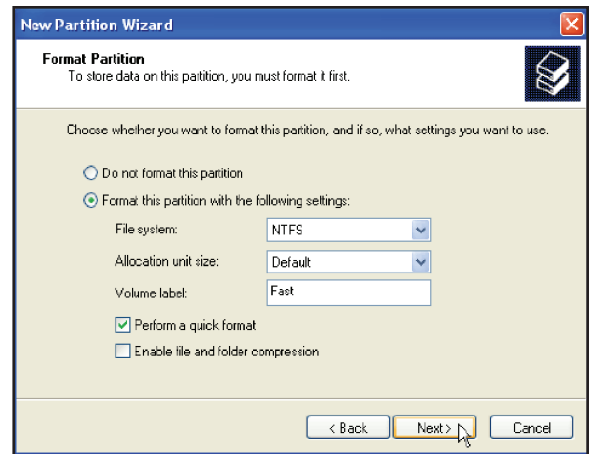

Fig. H

9. Review the settings and click **Finish** to create the logical partition (fig. I).

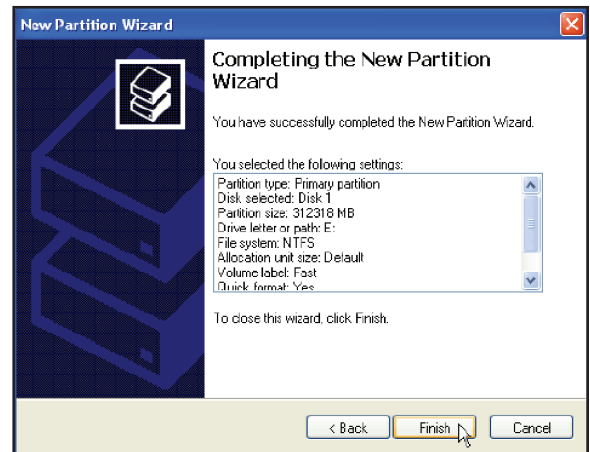

Fig. I

8. Click **Partition** to acknowledge the warning (*fig. C*).

Disk Utility mounts the created partition and represents it with an icon on the desktop. The icon is labeled with the partition name.

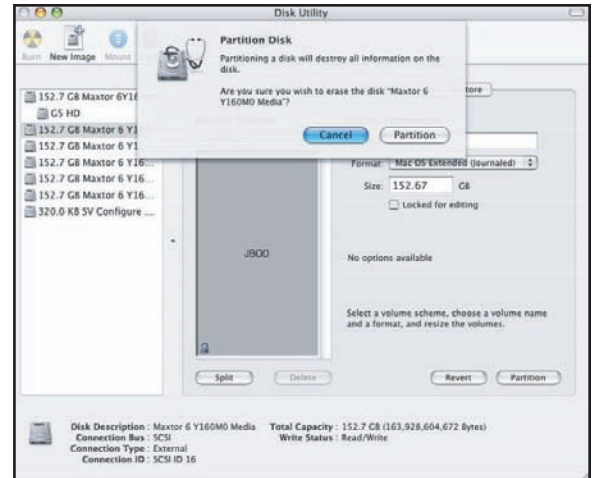

Fig. C

4. Maintaining Your LaCie Two Big

4.1. Removing/Replacing A Drive



IMPORTANT INFO: After continuous use of the LaCie Two Big, drives may be hot. Use caution when removing drives.

In the event that an individual hard disk fails in the LaCie Two Big, please contact your LaCie reseller or LaCie Customer Support. Additional, spare hard disks may also be purchased (sold separately). Please replace a defective hard drive only by a new drive provided by LaCie. For drive removal and replacement process, please follow the steps below.



CAUTION: Drive warranty will be void if you replace the defective drive by a drive not purchased from LaCie.

1. Remove the front panel by grasping the top corners, lifting slightly and then pulling forward on the panel removal tab.
2. Draw out the gray extraction handle by inserting your finger into the ring and pulling gently (*fig. A*).

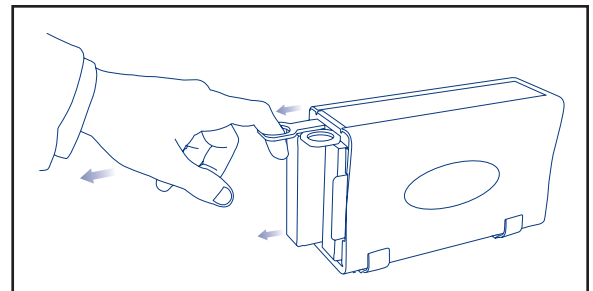

Fig. A

3. Grasp the hard drive.
4. Carefully extract the hard drive (*fig. B*).

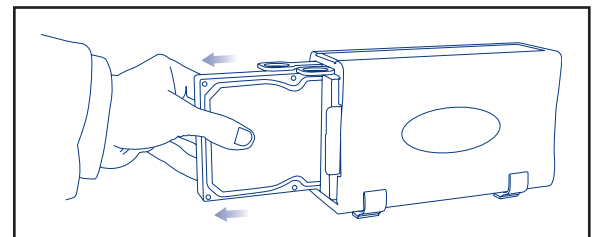

Fig. B

4.2. Install New Firmware (Upgrade)

LaCie may periodically offer firmware updates for the Two Big. Visit LaCie's Web site, www.lacie.com, for the latest firmware update. For the procedure, please contact the LaCie technical support.

5. LaCie Two Big Front Panel LED Indicators

Both disk drives and the system-to-host connections have LEDs that reflect the drive and system states. The following table shows the different LED states and their indications.

Table A: LED Display Lights				
LED	On (solid)	Off	Blinking	Flashing
Drive 1	Drive is rebuilding (blue)	Drive is not being accessed	Bad drive or disconnected from host	Normal read/write activity
Drive 2	Drive is rebuilding (blue)	Drive is not being accessed	Bad drive or disconnected from host	Normal read/write activity
System	Power on (green)	Power off or corrupt firmware	N/A	N/A

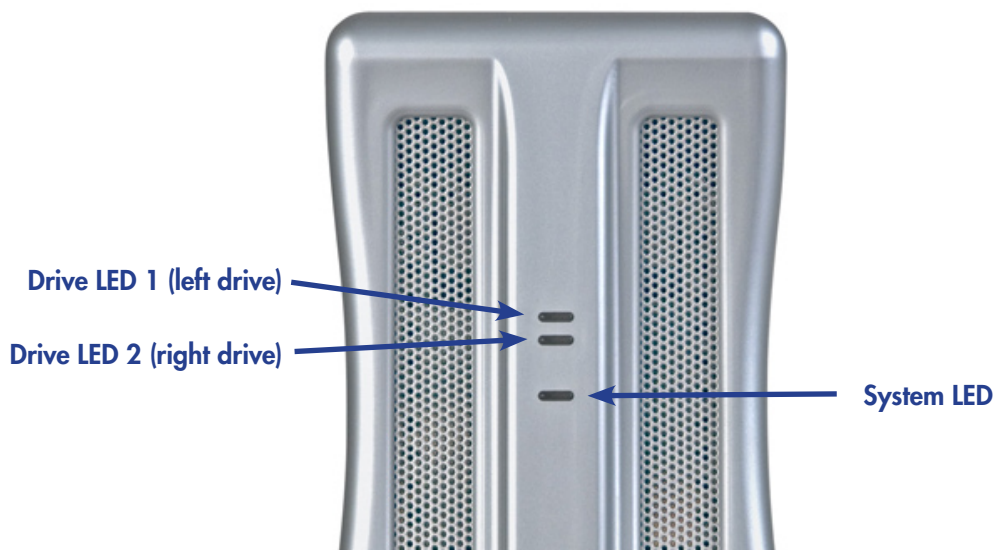

TECHNICAL NOTE: The easiest way to tell the difference between a blinking LED and a flashing LED is that flashing stops when the read/write activity is finished, and blinking does not stop. The blink rate is slower, too, but the difference in speed is more difficult to detect visually.

6. Tech Tips

6.1. Available Storage Capacity

A gigabyte (GB) means 1,000,000,000 bytes. In order to utilize a hard disk drive, it has to be formatted first. Formatting a disk consists of the following: the operating system erases all of the bookkeeping information on the disk, tests the disk to make sure that all of the sectors are reliable, marks bad sectors (i.e., those that are scratched) and creates internal address tables that it later uses to locate information. Once formatted, the actual available storage capacity varies, depending on operating environment, and is generally about 5 to 10% less than the non-formatted capacity.

 **TECHNICAL NOTE:** Storage capacity of an array depends on the RAID level. The capacity of a RAID array can be found by multiplying the capacity of the drives in the array by the number of non-redundant drives.

6.2. File System Formats

6.2.1. File System Formats – Mac Users

The LaCie Two Big comes preformatted in HFS+ (Mac OS Extended). This section will help you decide if you need to reformat your Two Big.

Mac OS 10.x Users:

You may customize the drive by reformatting and/or partitioning the drive with separate file system formats. For optimal performance in Mac OS environments, format and partition the drive as one large Mac OS Extended volume.

Mac OS Extended (HFS+)

Mac OS Extended refers to the file system used by Mac OS 8.1 and later. HFS+ represents an optimization of the older HFS file system by using hard disk space more efficiently. With HFS+, you are no longer limited by block size.

MS-DOS File System (FAT 32)

This is the Microsoft file system, more typically known as FAT 32. This is the file system to use if you are going to be using your LaCie Hard Drive between Macs and Windows operating systems.

IMPORTANT INFO: If you will be sharing the hard drive between Mac and Windows operating environments, you will want to follow these guidelines:

Mac OS X prefers that all partitions be the same format, therefore only the first FAT 32 partition is guaranteed to mount.

Mac OS 10.1.x

- Works reliably with FAT 32 partitions less than 32GB

Mac OS 10.2.x

- Works reliably with FAT 32 partitions less than 128GB
- Does not mount FAT 32 partitions greater than 128GB

Mac OS 10.3.x

- Mounts any FAT 32 drive of any size
- Mounts NTFS volumes as READ-only

TECHNICAL NOTE: Mac OS 10.3.x Users - Mac OS Extended (Journaled) Under Panther, Apple introduced journaling to the Mac OS Extended file system, which helps protect the file systems on Mac OS volumes. When journaling is enabled, file system transactions are maintained and recorded continuously in a separate file, called a journal. In the event of an unplanned shutdown, the OS uses the journal to restore the file system. Journaling is also backward compatible, and all volumes with journaling enabled can be fully used by computers not running Mac OS 10.3.x. For more information, please visit Apple's Web site.

6.2.2. File System Formats – Windows Users

Since the LaCie Two Big comes preformatted in HFS+, the Mac Operating system, you will need to reformat your drive in FAT 32 or NTFS. The following information will hopefully make choosing one or the other a little easier.

FAT 32

FAT is an acronym for *File Allocation Table*, which dates back to the beginnings of DOS programming. Originally, FAT was only 16 bits, but after the second release of Windows 95 it was upgraded to 32 bits, hence the name FAT 32. In theory, FAT 32 volume sizes can range from less than 1MB all the way to 2TB. It is the native file system of Windows 98 and Windows Me, and is supported by Windows 2000 and XP. When FAT 32 is used with Windows 2000 and XP, though, volume size is limited to 32GB (by the Windows partition utility, i.e. Disk Manager), and the individual file size is limited to 4GB.

NTFS

This acronym stands for New Technology Filing System, and it is the native file system for Windows NT, Windows 2000 and XP. NTFS offers several features that are not available with FAT 32; i.e. file compression, encryption, permissions, and auditing, as well as the ability to mirror drives and RAID 5 capabilities. The minimum supported volume size for NTFS is 10MB, with a maximum of 2TB, with no limit to file size. Volumes created in NTFS can only be directly accessed (not through shares) by Windows NT, Windows 2000 and XP, without resorting to help from third-party products.

Guidelines for Choosing FAT 32 Or NTFS

Use FAT 32 if:

- You want to access your data on any Operating System - FAT 32 is compatible with Windows 98 SE, Me, 2000, XP, NT, Mac OS 9.x and Mac OS 10.x (see the Important Info note in section 6.2.1. [File System Formats - Mac Users](#) for more information).
- You will be dual booting with an Operating System other than Windows NT or Windows 2000.
- You may need the ability to dual boot down the line. Once you have converted a volume from FAT 32 to NTFS, there is no going back. You can convert from FAT 32 to NTFS, but not the other way around.

Use NTFS if:

- You want to optimize drive performance under Windows 2000 or XP.
- You want to encrypt files, assign permissions to files, or want to audit files for access.
- You will be formatting partitions larger than 32GB.
- You need to store individual files that are larger than 4GB.
- You need a filing system that can be mirrored or structured like a RAID 5 configuration.

6.3. Serial ATA II Questions and Answers

What is Serial ATA II?

The Serial Advanced Technology Attachment (ATA) II marks the latest rung on the evolutionary ladder of SATA technology. SATA II can deliver data at 300MB/s, twice as fast as its SATA predecessor and more than twice as fast as the Parallel ATA/IDE (Integrated Drive Electronics) interface, which has long been used to connect peripheral devices to the computer. Initial Serial ATA technology removed the performance bottleneck of the Parallel ATA specification, and follows a clearly defined road-map to greater and greater data transfer rates and feature improvements.

Deriving its name from the way that it transmits signals, in a single stream, or serially, Serial ATA operates in a point-to-point topology. This connectivity methodology delivers the entire available interface bandwidth to each device, allowing each device to operate at its maximum throughput, and provides direct communication between the device and the system at any time, reducing arbitration delays associated with shared bus topologies.

What are the key differences between Serial ATA and Serial ATA II technology?

Serial ATA (SATA) II allows twice the transfer speed of Serial ATA and can support what's called a port multiplier. With a port multiplier, the controller (the PCI-X card) can communicate with multiple SATA drives from one host channel (this process is often called "Daisy Chaining"). One Serial ATA II channel from the PCI-X card can communicate with up to two disks in the Two Big.

What are the features and benefits of Serial ATA and Serial ATA II? The Serial ATA specification provides several key features that will help spur widespread implementation:

- **Performance:** Serial ATA is a point-to-point topology, and does not have to share the bus, instead dedicating full bandwidth to the device. These dedicated links make creating a Serial ATA RAID array quick and relatively inexpensive to implement.
- **Easy installation and configuration:** There are no device IDs, termination or master/slave conflicts, and the standard supports hot-plug connectivity. Drives can be added, upgraded or removed without having to power down the whole system.
- **Improved reliability:** Serial ATA also uses 32-bit cyclic redundancy checking (CRC) on all transfers to ensure correct data transmissions. Due to this CRC capability, Serial ATA performs protection and recovery features at multiple levels: PHY layer, link layer and transport and software layers.
- **Command optimization:** Serial ATA utilizes Native Command Queuing (NCQ) and first party direct memory access (DMA) to intelligently order commands in an internal queue within the drive, without having to involve the host CPU. Judging its

own drive head's angular and rotational position, the drive selects a data transfer from the queue that will minimize both its seek and rotational latencies.

- Simplified structure: Serial ATA utilizes a more efficient signaling voltage (250mV vs. 5V for Parallel ATA), and much smaller, thinner and compact cables and connectors. Due to the simplified cabling (the reduction in the number of pins and wires), the number of fault possibilities decreases.
- Seamless integration: Serial ATA maintains register and software compatibility with Parallel ATA, and should be transparent to both the BIOS and operating system. Simply add more Serial ATA links to increase the number of connectivity points in your system.

What are the ideal uses of Serial ATA?

Although the specification supports all ATA and ATAPI devices (i.e. CD, DVD, tape drives, etc.), and delivers superior performance than both Hi-Speed USB 2.0 and FireWire/IEEE 1394, external Serial ATA connectors are intended for storage devices. Serial ATA works best in storage environments that require high data throughput to deliver large files quickly and efficiently, maximizing the storage systems utilization and enhancing overall productivity.

Due to its performance, reliability, scalability and cost-effectiveness, Serial ATA can be implemented in a wide-range of settings, from desktop usage to network storage applications.

7. Understanding RAID and Two Big Storage Policies

Your LaCie Two Big supports several different RAID levels: 0, 1, Concatenation, and JBOD. This section will help you decide which RAID level is right for your application. The storage policies of the LaCie Two Big — Safe, Fast, Big and JBOD are combinations of these RAID levels.

7.1. Fast (RAID 0)

Striped Disk Array Without Fault Tolerance

Also called *striping*, this level offers high transfer rates and is ideal for large blocks of data where speed is of the utmost importance. RAID 0 implements a striped disk array, where all of the hard disks are linked together to form one large aggregate hard disk (*fig. A*). In this configuration, data is broken down into blocks and each block is written to a separate disk drive within the array; I/O performance is greatly improved by spreading the I/O load across several drives. In this array, however, when one disk fails, all of the data on the array is lost.

Storage capacity is determined by the smallest disk in the array, and the smallest disk's capacity is applied to all of the other disks in the array. So, for instance, if you had four disks installed, ranging in capacity from 40GB to 80GB, when the RAID 0 array is built your system will see one, 160GB (40GB x 4) hard disk.

While this is a very simple and easily implemented design, RAID 0 should never be used in mission critical environments. When even just one disk in the array fails, all of the data on the entire array will be lost.

Characteristics & Advantages

- Data is broken down into blocks and each block is written to a separate disk drive
- I/O performance improved by spreading the load across multiple drives
- Overhead is lowered due to no calculations for parity
- Simple design and easily implemented

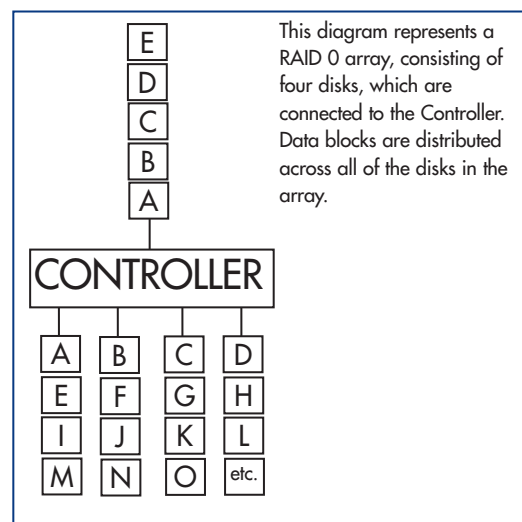

Fig. A

Recommended Uses

- Video production and editing
- Image editing
- Pre-press applications
- Applications requiring high-bandwidth

7.2. Safe (RAID 1)

Mirroring and Duplexing

Also called mirroring, this level makes a duplicate write on a second or “mirror” disk every time data is written to a primary disk. If one disk crashes, there is an ideal backup (*fig. A*).

Using two controllers, or duplexing, can speed the data I/O rate by writing to both drives at the same time. When using just a single controller operations are slowed because data is written first to the data drive and then to the mirrored drive.

The storage capacity of a two-disk RAID 1 array is equal to the storage capacity of a single disk because the same data is duplicated on both disks. However, the 100 percent redundancy of data does not require a rebuild in the case of a drive failure. In that case, data can be copied to a replacement disk.

Characteristics & Advantages

- Can sustain multiple simultaneous drive failures in most cases
- Simplest RAID storage subsystem design
- Transfer rate for each block is the same as that of a single disk
- Data is 100 percent redundant

Recommended Uses

- Payroll
- Accounting
- Financial
- Any use that requires high availability

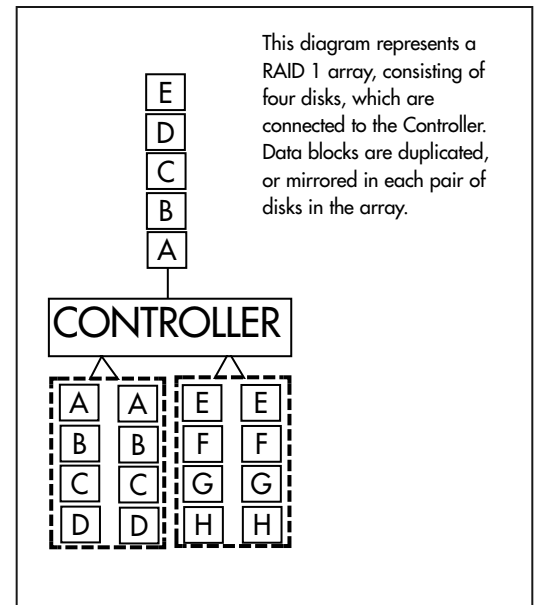

Fig. A

7.3. Big (Concatenation)

Maximum Capacity Solution

A concatenated volume, or concatenation, is a volume whose data is organized serially and adjacently across components, forming one logical storage unit. If you have 3 6GB disks in a concatenation, you'll have one 18G virtual disk. You'll write data to the first drive until it fills, then fill the second, etc (*fig. A*).

A concatenation enables you to dynamically expand storage capacity and file system sizes online. With a concatenation you can add components even if the other components are currently active.

Characteristics & Advantages

- In case of disc failure, other disks are unaffected.
- Combine the capacities of two drives into one large volume.

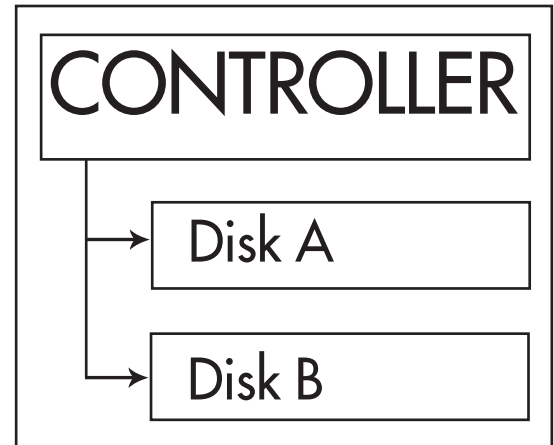

Fig. A

7.4. JBOD

Just a Bunch of Disks

JBOD, or Just a Bunch of Disks, is not a numbered RAID level. However, it is similar because it is an Array of Inexpensive Disks.

In a JBOD configuration, each connected drive will appear as separate hardware entries in the computer's drive utility software. A JBOD array is the simplest storage policy available to the Two Big but provides no data redundancy (*fig. A*).

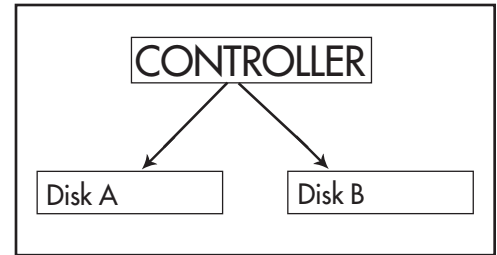

Fig. A

8. Troubleshooting

In the event that your LaCie Two Big is not working correctly, please refer to the following checklist to find out where the problem is coming from. If you have gone through all of the points on the checklist and your drive is still not working correctly, please have a look at the FAQs that are regularly published on our Web site – www.lacie.com. One of these FAQs may provide an answer to your specific question. You can also visit the drivers pages, where the most recent software updates will be available.

If you need further assistance, please contact your LaCie reseller or LaCie Technical Support (see chapter 9. [Contacting Customer Service](#) for details).

TECHNICAL NOTE:

Manual Updates

LaCie is constantly striving to give you the most up-to-date, comprehensive User's Manuals available on the market. It is our goal to provide you with a friendly, easy-to-use format that will help you quickly install and utilize the many functions of your new device.

If your manual does not reflect the configurations of the product that you purchased, please check our Web site for the most current version available.

8.1. LEDs and Fan

Problem	Solution
System LED is off.	Confirm power at the outlet, verify power connection, and try an alternate power cable.
	Install new firmware.
Drive 1 or Drive 2 LED is blinking.	Evaluate the drive for failure and replace if needed.
	See HBA connection below.
Drive 1 or Drive 2 LED is on continuously.	A Safe virtual drive is rebuilding on the physical drive.
System fan is not running.	Confirm the outlet is powered, verify power connections, and try an alternate power cable. The fan on the LaCie Two Big does not run continuously; it is activated at certain temperatures.

8.2. LaCie Two Big connection to LaCie SATA II 3Gb/s PCI-X Card 4E

Problem	Solution
LaCie Two Big is not recognized by HBA BIOS.	Verify the System LED status to confirm power.
	Verify the eSATA connection and try an alternate eSATA cable.
	Verify HBA BIOS recognizes empty LaCie Two Big.
	Turn off PCI bus power save mode in the host BIOS.
	Troubleshoot the HBA: <ul style="list-style-type: none"> • Connect to an alternate SATA port. • Connect an alternate device to the HBA. • Remove all other PCI peripherals to rule out interference. • Move the HBA to an alternate PCI-X slot. • Try the HBA in a PCI slot.
Operating system does not recognize LaCie virtual drives.	Verify HBA BIOS recognizes empty LaCie Two Big.
	Before reconfiguring the mode of operation, use the operating system's Disk Manager to delete partitions on the volume.
	Ensure the HBA driver is current.
	Troubleshoot driver: <ul style="list-style-type: none"> • Verify driver active status. For Windows, the Device Manager should show the SCSI icon next to the HBA. For Mac OS X, the Disk Utility should show a SCSI Connection ID for the virtual disks on the physical hard disk drives. Error messages during the driver installation would have indicated issues. • Resolve resource conflicts (IRQ, DMA, or I/O).
	Identify maximum SATA disk drive capacity supported by the operating system and ensure the volume size meets the limits.
Verify port multiplier (PM) support in the HBA.	

9. Contacting Customer Support

Before You Contact Technical Support

- 1) Read the manuals and review section 8. [Troubleshooting](#).
- 2) Try to isolate the problem. If possible, make the drive the only external device on the CPU, and make sure that all of the cables are correctly and firmly attached.

If you have asked yourself all of the pertinent questions in the troubleshooting checklist, and you still can't get your LaCie drive to work properly, contact us at www.lacie.com. Before contacting us, make sure that you are in front of your computer and that you have the following information on hand:

- Your LaCie drive's serial number
- Operating system (Mac OS or Windows) and version
- Computer brand and model
- Names of CD or DVD drives installed on your computer
- Amount of memory installed
- Names of any other devices installed on your computer

LaCie Technical Support

<p>LaCie Asia, Singapore, and Hong Kong Contact us at: http://www.lacie.com/asia/contact/</p>	<p>LaCie Australia Contact us at: http://www.lacie.com/au/contact/</p>
<p>LaCie Belgium Contact us at: http://www.lacie.com/be/contact/</p>	<p>LaCie Canada Contact us at: http://www.lacie.com/caen/contact/ (English)</p>
<p>LaCie Denmark Contact us at: http://www.lacie.com/dk/contact</p>	<p>LaCie Finland Contact us at: http://www.lacie.com/fi/contact/</p>
<p>LaCie France Contact us at: http://www.lacie.com/fr/contact/</p>	<p>LaCie Germany Contact us at: http://www.lacie.com/de/contact/</p>
<p>LaCie Italy Contact us at: http://www.lacie.com/it/contact/</p>	<p>LaCie Japan Contact us at: http://www.lacie.com/jp/contact/</p>
<p>LaCie Netherlands Contact us at: http://www.lacie.com/nl/contact/</p>	<p>LaCie Norway Contact us at: http://www.lacie.com/no/contact/</p>
<p>LaCie Spain Contact us at: http://www.lacie.com/es/support/request/</p>	<p>LaCie Sweden Contact us at: http://www.lacie.com/se/contact</p>
<p>LaCie Switzerland Contact us at: http://www.lacie.com/chfr/contact/</p>	<p>LaCie United Kingdom & Ireland Contact us at: http://www.lacie.com/uk/support/request/</p>
<p>LaCie USA Contact us at: http://www.lacie.com/contact/</p>	<p>LaCie Grand Export Contact us at: http://www.lacie.com/intl/contact/</p>

10. Warranty

LaCie warrants your LaCie Two Big and Drive Bays against any defect in material and workmanship, under normal use, for the period designated on your warranty certificate. In the event this product is found to be defective within the warranty period, LaCie will, at its option, repair or replace the defective LaCie Two Big and/or Drive Bay(s).

In the event of a drive failure and in absence of a spare drive bought from LaCie at initial product purchase, please contact your LaCie reseller or LaCie customer support for drive replacement procedure.

This warranty is void if:

- The LaCie Two Big was operated/stored in abnormal use or maintenance conditions;
- The LaCie Two Big is repaired, modified or altered, unless such repair, modification or alteration is expressly authorized in writing by LaCie;
- The LaCie Two Big was subjected to abuse, neglect, lightning strike, electrical fault, improper packaging or accident;
- The LaCie Two Big was installed improperly;
- The serial number of the LaCie Two Big or an individual Drive Bay is defaced or missing;
- The broken part is a replacement part such as a pickup tray, etc.
- The tamper seal on the LaCie Two Big or an individual Drive Bay casing is broken.

The warranty of the drives inside the LaCie Two Big is void if:

- One or two of the hard disks have been removed and replaced by any hard disk other than a drive provided by LaCie. For drive removal/replacement process, see section 4.1. [Removing/Replacing a Drive](#).

LaCie and its suppliers accept no liability for any loss of data during the use of this device, or for any of the problems caused as a result.

LaCie will not, under any circumstances, be liable for direct, special or consequential damages such as, but not limited to, damage or loss of property or equipment, loss of profits or revenues, cost of replacement goods, or expense or inconvenience caused by service interruptions.

Any loss, corruption or destruction of data while using a LaCie drive is the sole responsibility of the user, and under no circumstances will LaCie be held liable for the recovery or restoration of this data.

Under no circumstances will any person be entitled to any sum greater than the purchase price paid for the drive.

To obtain warranty service, call LaCie Technical Support. You will be asked to provide your LaCie product's serial number, and you may be asked to furnish proof of purchase to confirm that the drive is still under warranty.

All systems returned to LaCie must be securely packaged in their original box and shipped with postage prepaid.